

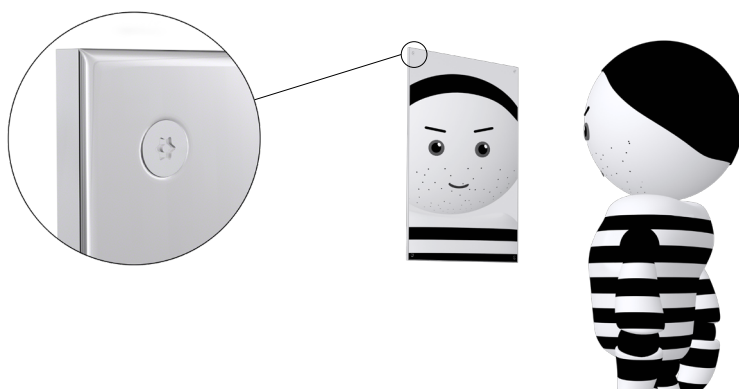

- FICHE TECHNIQUE -

MIROIR INCASSABLE EN INOX : AX6865P-445X597



TYPE DE PRODUIT :

Miroir incassable en inox

MATÉRIAUX ET FINITION :

En inox 304 (18/10) Poli Miroir HyperPolish

RÉFÉRENCE DU PRODUIT :

AX6865P-445X597

CARACTÉRISTIQUES :

Bactériostatique

Incassable

Monobloc

Fixation par quatre vis encastrées anti-vandalisme qui affleurent la surface

DIMENSIONS :

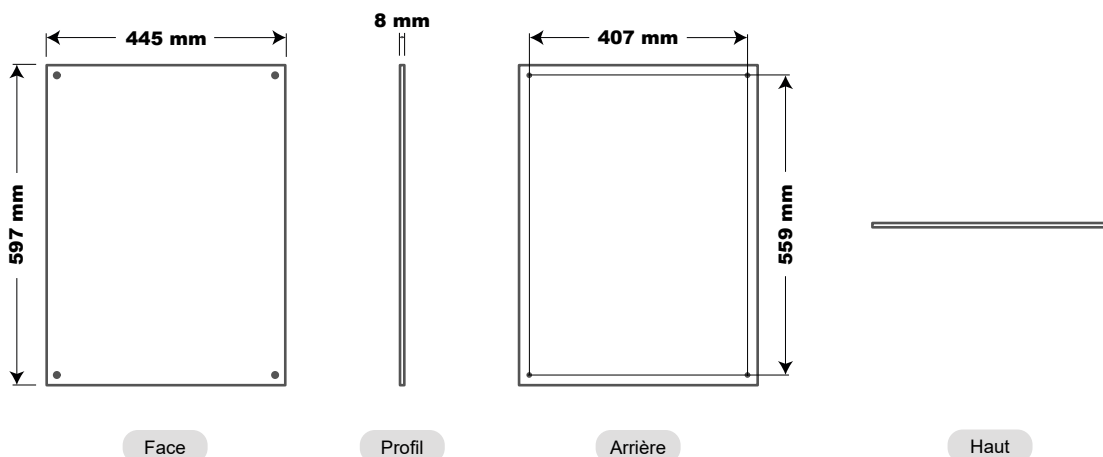

LIVRÉ AVEC :

4 vis anti-vandalisme / 4 chevilles



- FICHE TECHNIQUE -

MIROIR INCASSABLE EN INOX : AX6865P-445X597

CONDITIONNEMENT :

Unitaire dans un emballage carton

LIEUX D'UTILISATION :



Milieu carcéral, lieux de haute sécurité, lieux publics, usines...



HAUTEURS DE POSE RECOMMANDÉES :

Bas des miroirs à 90 cm du sol.

Plus d'informations sur notre site : <https://axeuro.com/hp>

AVANTAGES ET CERTIFICATIONS :

Résiste à un usage intensif	
Bactériostatique	
Anti-vandalisme	

Respecte la planète	
Milieu carcéral, lieux de haute sécurité	
Garantie	

LES DIFFÉRENTS PRODUITS :



En 400 mm X 600 mm :
AX6865P



En 300 mm X 300 mm :
AX6865P-300X300



En 394 mm X 495 mm :
AX6865P-394X595



En 445 mm X 597 mm :
AX6865P-457X597



En 600 mm X 700 mm :
AX6865P-600X700

LES AUTRES MIROIRS INCASSABLES :

<https://www.axeuro.com/fr/262-miroirs-de-securite-incassables-en-inox>

